

917687-1 ✓ ACTIVE

AMP Signal Double Lock

TE Internal #: 917687-1

AMP Signal Double Lock, Housing, Plug, Wire-to-Wire, 3 Position, 2.5mm [.098in] Centerline, Crimp, 1 Row, Natural Housing Color, Mating Retention

[View on TE.com >](#)



Connectors > PCB Connectors > Wire-to-Board Connectors > Wire-to-Board Connector Assemblies & Housings >

STD Temp Signal Double Lock Plug

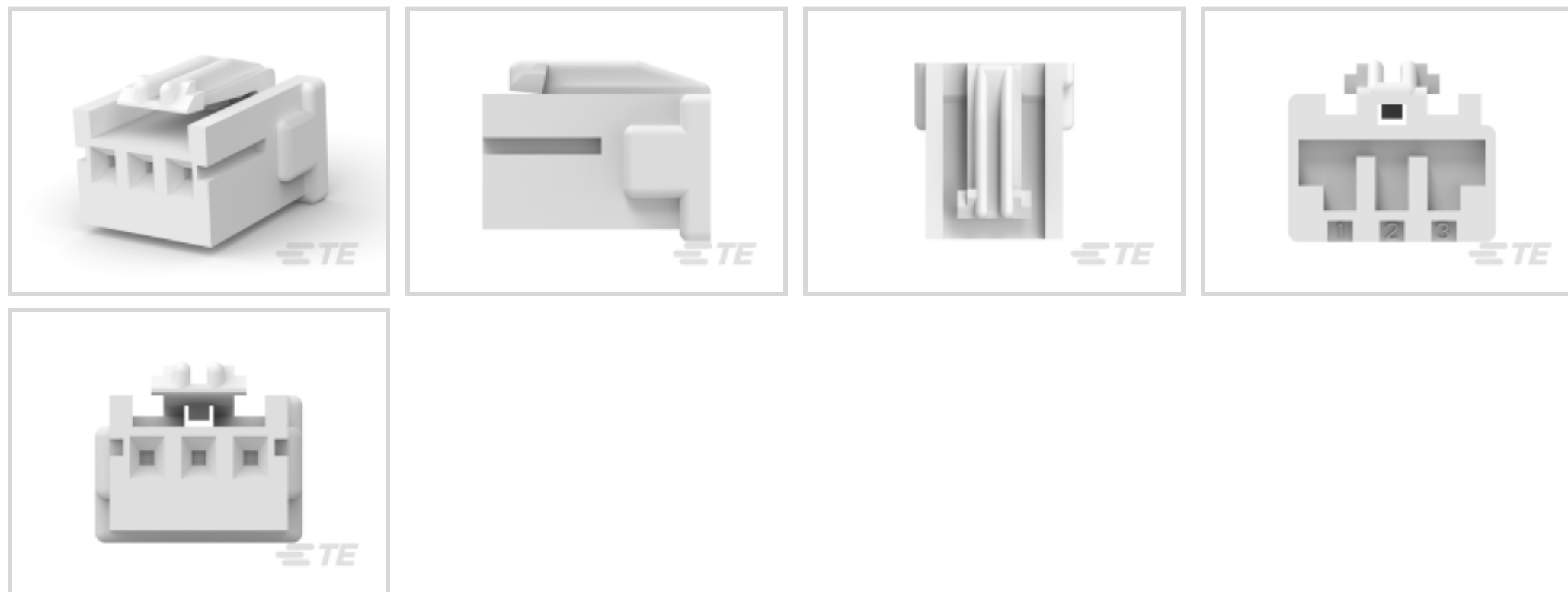

Connector Product Type: **Housing**

Connector & Housing Type: **Plug**

Connector System: **Wire-to-Wire**

Number of Positions: **3**

Centerline (Pitch): **2.5 mm [.098 in]**

[All STD Temp Signal Double Lock Plug \(35\)](#)

Features

Product Type Features

Connector Product Type	Housing
Connector & Housing Type	Plug
Connector System	Wire-to-Wire
Sealable	No
Connector & Contact Terminates To	Wire & Cable

Configuration Features

Number of Positions	3
Number of Rows	1

Electrical Characteristics

Operating Voltage	250 VAC
-------------------	---------

Contact Features

--	--



Contact Layout	Inline
Contact Type	Socket
Contact Current Rating (Max)	3 A

Termination Features

Termination Method to Wire & Cable	Crimp
------------------------------------	-------

Mechanical Attachment

Strain Relief	Without
Mating Retention Type	Latch
Mating Retention	With
Connector Mounting Type	Cable Mount (Free-Hanging)

Housing Features

Housing Material	Nylon 6/6
Centerline (Pitch)	2.5 mm [.098 in]
Housing Color	Natural

Dimensions

	11 in
Wire Size	.518 mm ²

Usage Conditions

Operating Temperature Range	-30 – 105 °C [-22 – 221 °F]
-----------------------------	-----------------------------

Operation/Application

Circuit Application	Power & Signal
---------------------	----------------

Industry Standards

Glow Wire Rating	Glow Wire
UL Flammability Rating	UL 94V-0

Packaging Features

Packaging Quantity	400
Packaging Method	Bag/Box

Product Compliance

For compliance documentation, visit the product page on [TE.com](#)>

EU RoHS Directive 2011/65/EU	Compliant
EU ELV Directive 2000/53/EC	Compliant



China RoHS 2 Directive MIIT Order No 32, 2016	No Restricted Materials Above Threshold
EU REACH Regulation (EC) No. 1907/2006	Current ECHA Candidate List: JUN 2020 (209) Candidate List Declared Against: JAN 2020 (205) Does not contain REACH SVHC
Halogen Content	Low Halogen - Br, Cl, F, I < 900 ppm per homogenous material. Also BFR/CFR/PVC Free
Solder Process Capability	Not applicable for solder process capability

Product Compliance Disclaimer

This information is provided based on reasonable inquiry of our suppliers and represents our current actual knowledge based on the information they provided. This information is subject to change. The part numbers that TE has identified as EU RoHS compliant have a maximum concentration of 0.1% by weight in homogenous materials for lead, hexavalent chromium, mercury, PBB, PBDE, DBP, BBP, DEHP, DIBP, and 0.01% for cadmium, or qualify for an exemption to these limits as defined in the Annexes of Directive 2011/65/EU (RoHS2). Finished electrical and electronic equipment products will be CE marked as required by Directive 2011/65/EU. Components may not be CE marked. Additionally, the part numbers that TE has identified as EU ELV compliant have a maximum concentration of 0.1% by weight in homogenous materials for lead, hexavalent chromium, and mercury, and 0.01% for cadmium, or qualify for an exemption to these limits as defined in the Annexes of Directive 2000/53/EC (ELV). Regarding the REACH Regulation, the information TE provides on SVHC in articles for this part number is based on the latest European Chemicals Agency (ECHA) 'Guidance on requirements for substances in articles' posted at this URL: <https://echa.europa.eu/guidance-documents/guidance-on-reach>

Compatible Parts

 <p>TE Model / Part # CAT-SI261-C1701 STD Temp Signal Double Lock Cap</p>	 <p>TE Model / Part # CAT-SI261-R2435 Signal Double Lock Receptacle</p>	 <p>TE Model / Part # 917723-1 2.5 SIGNAL D/LOCK HDR ASSY 3P</p>	 <p>TE Model / Part # 917781-1 2.5 S.D.L POST/HDR ASY 3P STD</p>
 <p>TE Model / Part # 234605-1 EXT-TOOL</p>	 <p>TE Model / Part # 316879-1 2.5 S.D.LOCK 2P HDR ON TAPE</p>	 <p>TE Model / Part # 353205-1 2.5 S.D.L HDR ASSY 2P H/PRO</p>	 <p>TE Model / Part # 316880-1 2.5 S.D.L. HDR 3P STD V O/TAPE</p>



Also in the Series | AMP Signal Double Lock

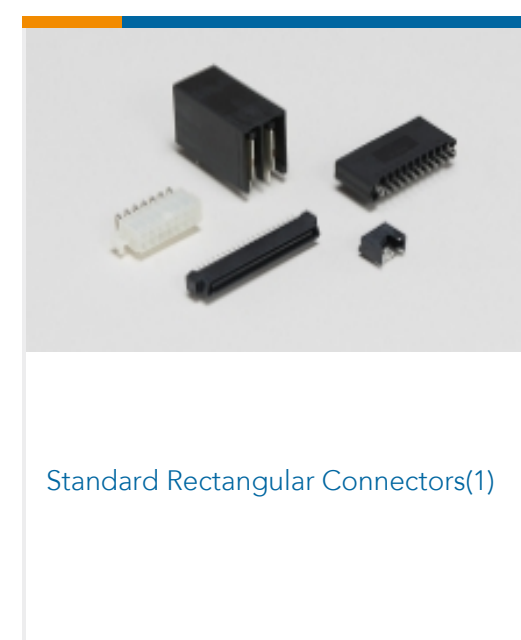
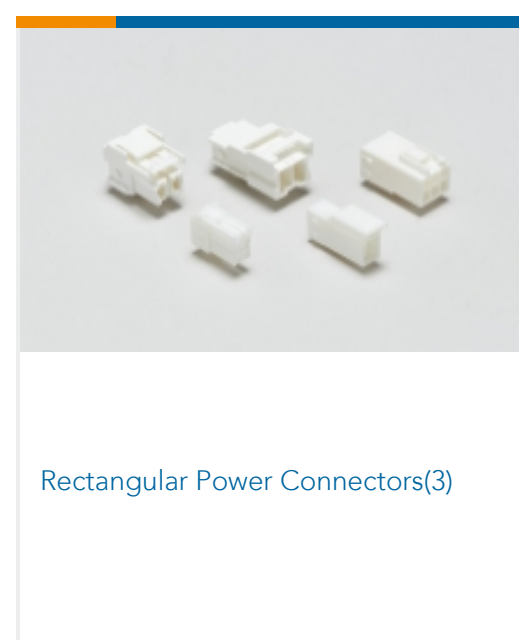
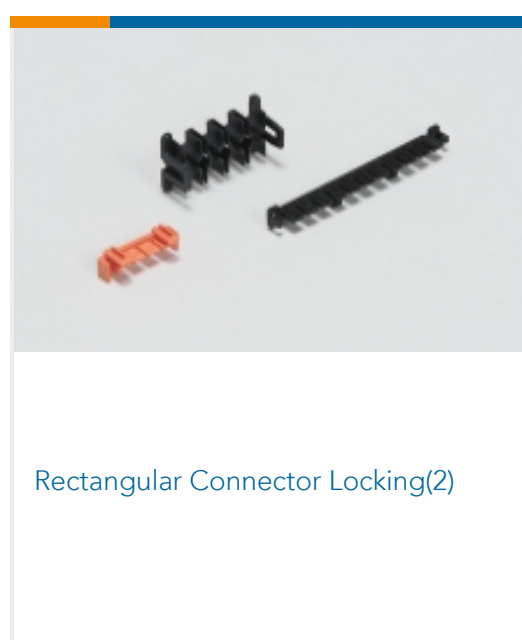
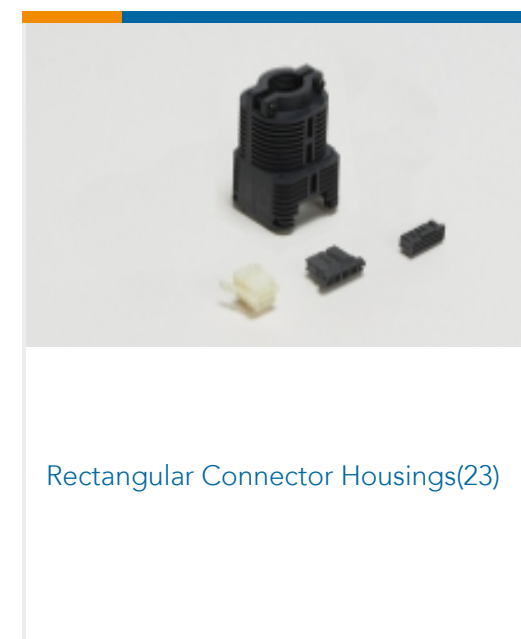
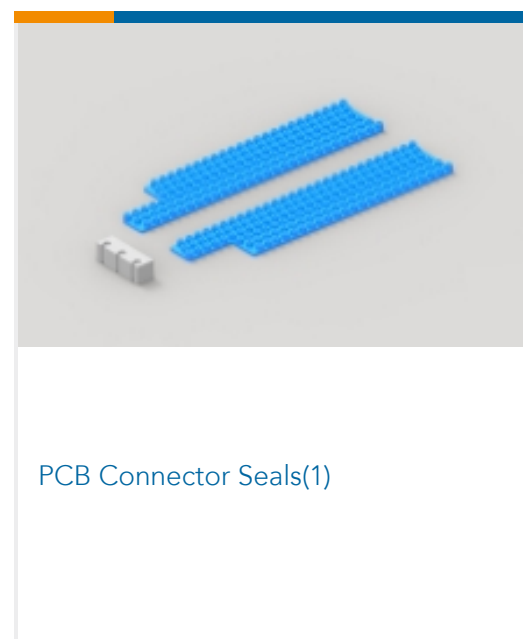
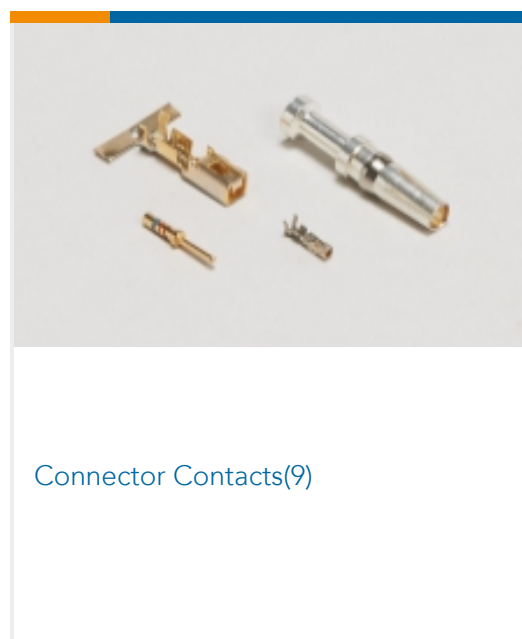

Wire-to-Board Connector Assemblies
& Housings(74)

Wire-to-Board Connector Contacts(6)

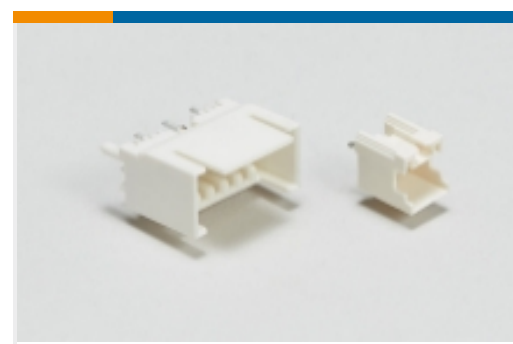
Wire-to-Board Headers & Receptacles
(157)

Documents

Product Drawings

2.5 SIGNAL D/LOCK PLUG HSG 3P

English

CAD Files

3D PDF

3D

Customer View Model

[ENG_CVM_CVM_917687-1_L.2d_dxf.zip](#)

English

Customer View Model

[ENG_CVM_CVM_917687-1_L.3d_igs.zip](#)

English

Customer View Model

[ENG_CVM_CVM_917687-1_L.3d_stp.zip](#)

English

By downloading the CAD file I accept and agree to the [Terms and Conditions](#) of use.

Datasheets & Catalog Pages

SOFT_SHELL_PIN_AND_SOCKET_CONNECTORS_CATALOG

English

1773458-3_2.5MM_SIGNAL_DOUBLE_LOCK_CONNECTORS

English

Product Specifications

Application Specification

English

Conditions of 2.5mm Signal Double Lock Contacts

English

Product Environmental Compliance

MD_917687-1_060520181220_dmtec

English

MD_917687-1_060520181220_dmtec

English



[Agency Approvals](#)

[UL Report](#)

English